

	PAA132	Units
Blocking Voltage	60	V _P
Load Current	600	mA
Max R _{ON}	1	Ω

Features

- Small 8-Pin Package
- TTL/CMOS Compatible
- No Moving Parts
- High Reliability
- Arc-Free With No Snubbing Circuits
- 3750V_{rms} Input/Output Isolation
- No EMI/RFI Generation
- Machine Insertable, Wave Solderable
- Surface Mount Tape & Reel Version Available

Applications

- Instrumentation
 - Multiplexers
 - Data Acquisition
 - Electronic Switching
 - I/O Subsystems
 - Meters (Watt-Hour, Water, Gas)
- Medical Equipment—Patient/Equipment Isolation
- Security
- Aerospace
- Industrial Controls
- Automotive

Description

The dual 1-Form-A PAA132 Solid State Relay has two independent, optically coupled, normally open, single-pole relays in a single 8-pin package. Clare's patented OptoMOS architecture makes available the optically coupled technology necessary to activate the output's efficient MOSFET switches while providing a 3750V_{rms} input-to-output isolation barrier. Control of the isolated output is accomplished by means of a highly effective GaAlAs infrared LED at the input.

By incorporating two independent single-pole relays into a single 8-pin package, the PAA132 saves board space by providing a more compact design solution than two discrete single-pole relays in a variety of applications.

Approvals

- UL recognized: File Number E76270
- CSA Certified: File Number LR43639-10
- EN/IEC 60950-1 compliant

Ordering Information

Part #	Description
PAA132	8 Pin DIP (50/Tube)
PAA132S	8 Pin Surface Mount (50/Tube)
PAA132STR	8 Pin Surface Mount (1,000/Reel)

Pin Configuration

PAA132 Pinout

AC/DC Configuration

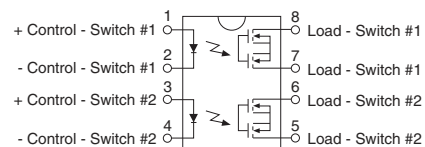

Switching Characteristics of Normally Open (Form A) Devices

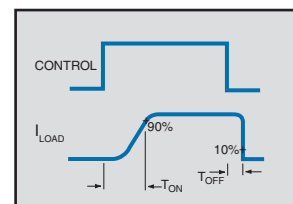

Absolute Maximum Ratings (@ 25° C)

Parameter	Ratings	Units
Blocking Voltage	60	V _P
Reverse Input Voltage	5	V
Input Control Current Peak (10ms)	50	mA
	1	A
Input Power Dissipation ¹	150	mW
Total Power Dissipation ²	800	mW
Isolation Voltage, Input to Output	3750	V _{rms}
Operational Temperature	-40 to +85	°C
Storage Temperature	-40 to +125	°C

¹ Derate Linearly 1.33 mw / °C

² Derate Linearly 6.67 mw / °C

Absolute Maximum Ratings are stress ratings. Stresses in excess of these ratings can cause permanent damage to the device. Functional operation of the device at conditions beyond those indicated in the operational sections of this data sheet is not implied.

Electrical Characteristics

Parameter	Conditions	Symbol	Min	Typ	Max	Units
Output Characteristics @ 25°C						
Load Current	-	I _L	-	-	600	mA
Peak	t≤10ms	I _{LPK}	-	-	2.0	A
On-Resistance	I _L =600mA	R _{ON}	-	0.85	1.0	Ω
Off-State Leakage Current	V _L =60V	I _{LEAK}	-	-	1	μA
Switching Speeds						
Turn-On	I _F = 5mA, V _L = 10V	T _{ON}	-	-	5	ms
Turn-Off		T _{OFF}	-	-	2	ms
Output Capacitance	V _L = 50V, f=1MHz	C _{OUT}	-	25	-	pF
Input Characteristics @ 25°C						
Input Control Current	I _L = 600mA	I _F	-	-	2	mA
Input Dropout Current	-	I _F	0.2	-	-	mA
Input Voltage Drop	I _F = 10mA	V _F	0.9	1.2	1.4	V
Reverse Input Current	V _R = 5V	I _R	-	-	10	μA
Common Characteristics @ 25°C						
Capacitance Input to Output	-	C _{I/O}	-	3	-	pF

¹ If both poles operate, the load current must be derated so that the package power dissipation value is not exceeded.

PERFORMANCE DATA*

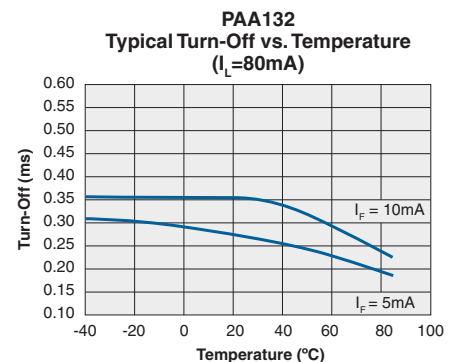
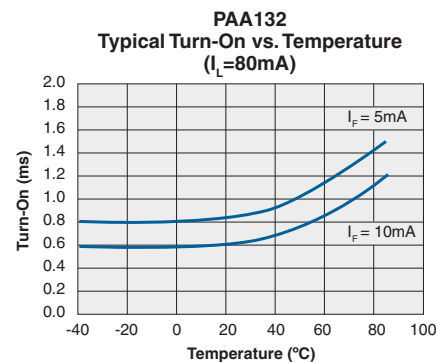
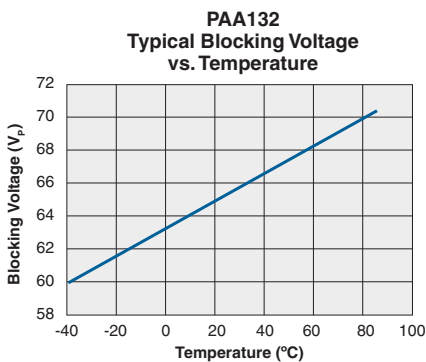
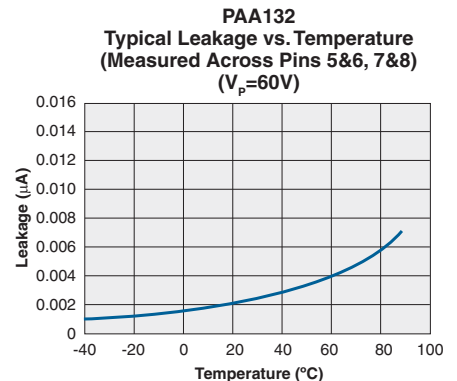
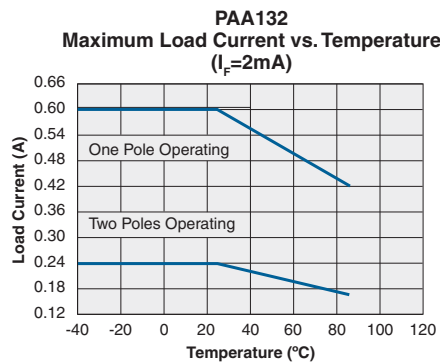
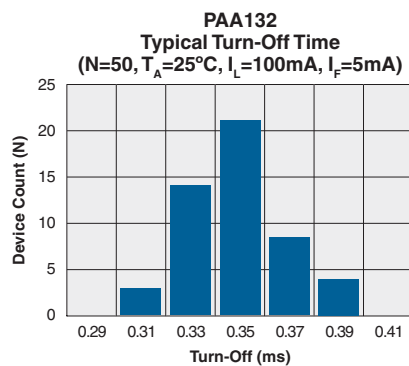
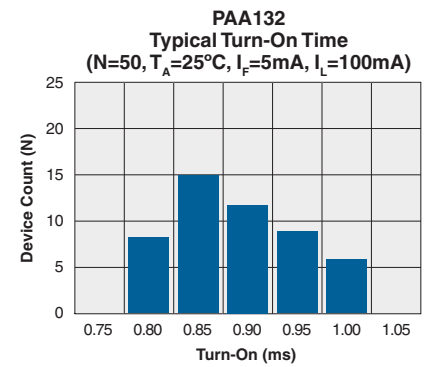
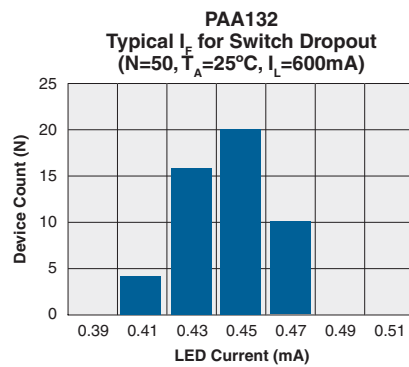
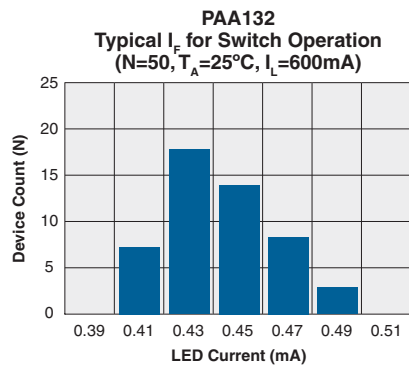
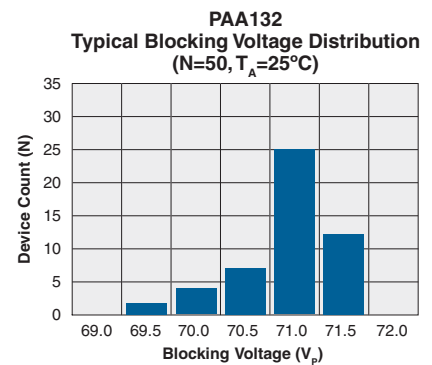
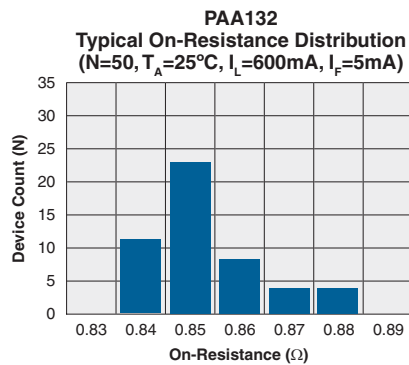
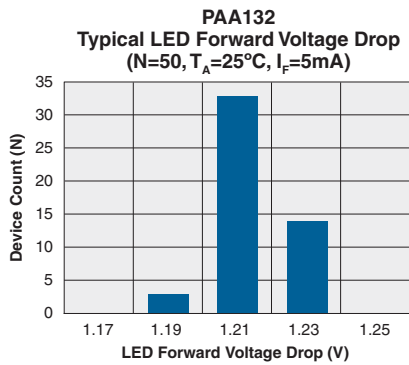

*The Performance data shown in the graphs above is typical of device performance. For guaranteed parameters not indicated in the written specifications, please contact our application department.

PERFORMANCE DATA*

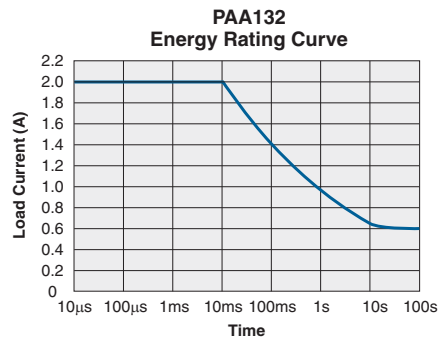
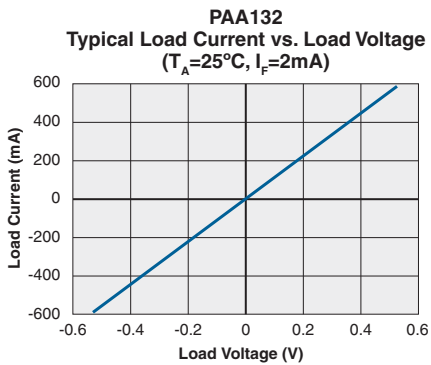
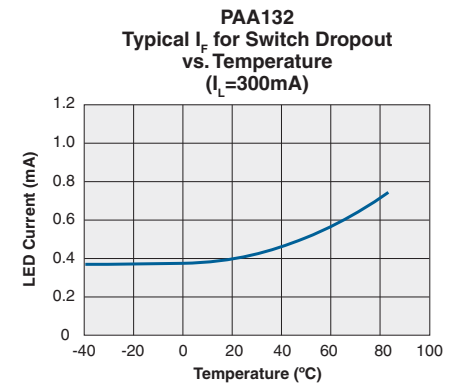
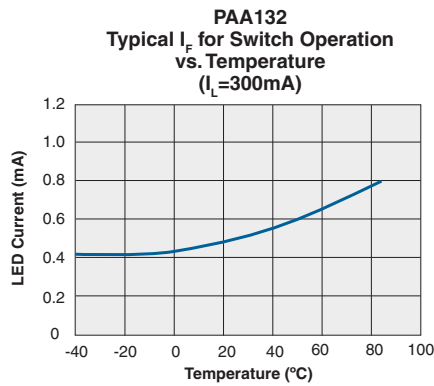
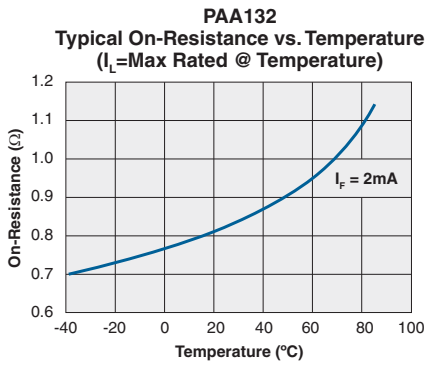
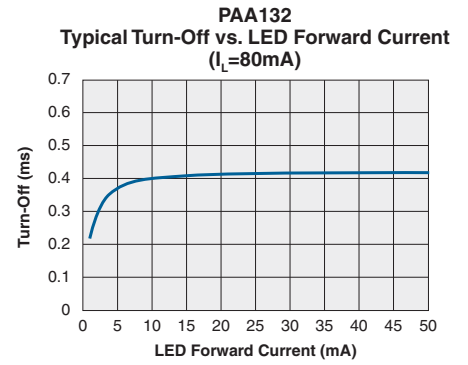
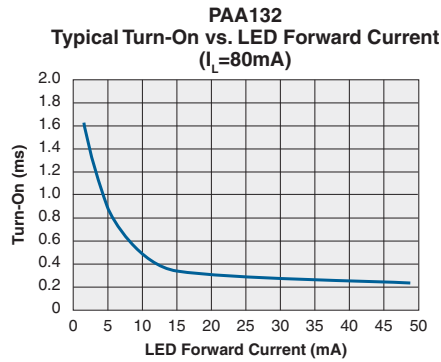
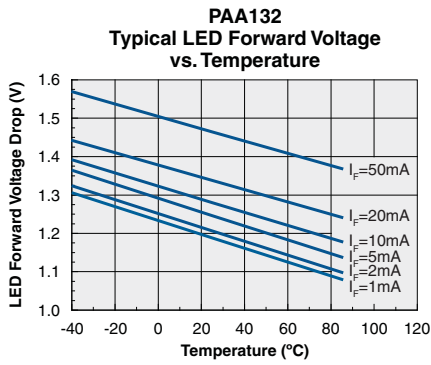

*The Performance data shown in the graphs above is typical of device performance. For guaranteed parameters not indicated in the written specifications, please contact our application department.

Manufacturing Information

Soldering

For proper assembly, the component must be processed in accordance with the current revision of IPC/JEDEC standard J-STD-020. Failure to follow the recommended guidelines may cause permanent damage to the device resulting in impaired performance and/or a reduced lifetime expectancy.

Washing

Clare does not recommend ultrasonic cleaning or the use of chlorinated solvents.



MECHANICAL DIMENSIONS

8-Pin DIP Through-Hole Package

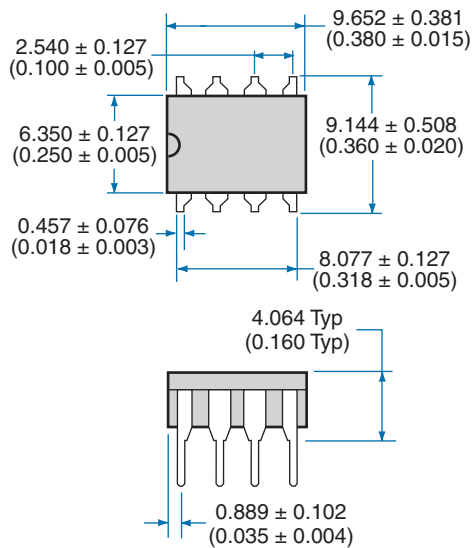

PC Board Pattern

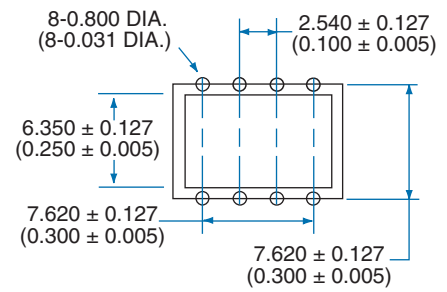

Dimensions
mm
(inches)

8-Pin Surface Mount Package

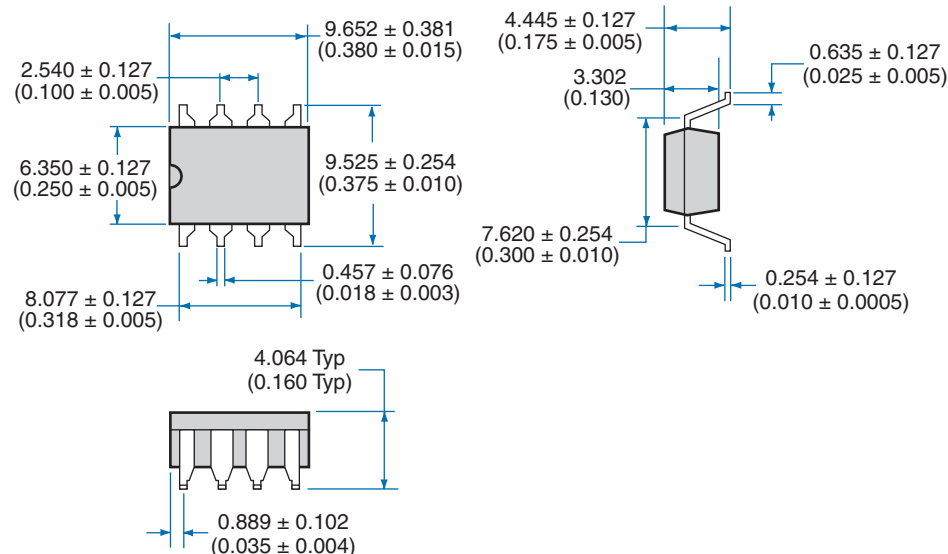

Recommended PCB Land Pattern

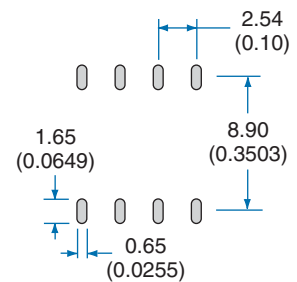

Dimensions
mm
(inches)

MECHANICAL DIMENSIONS

Tape and Reel Packaging for 8-Pin Surface Mount Package

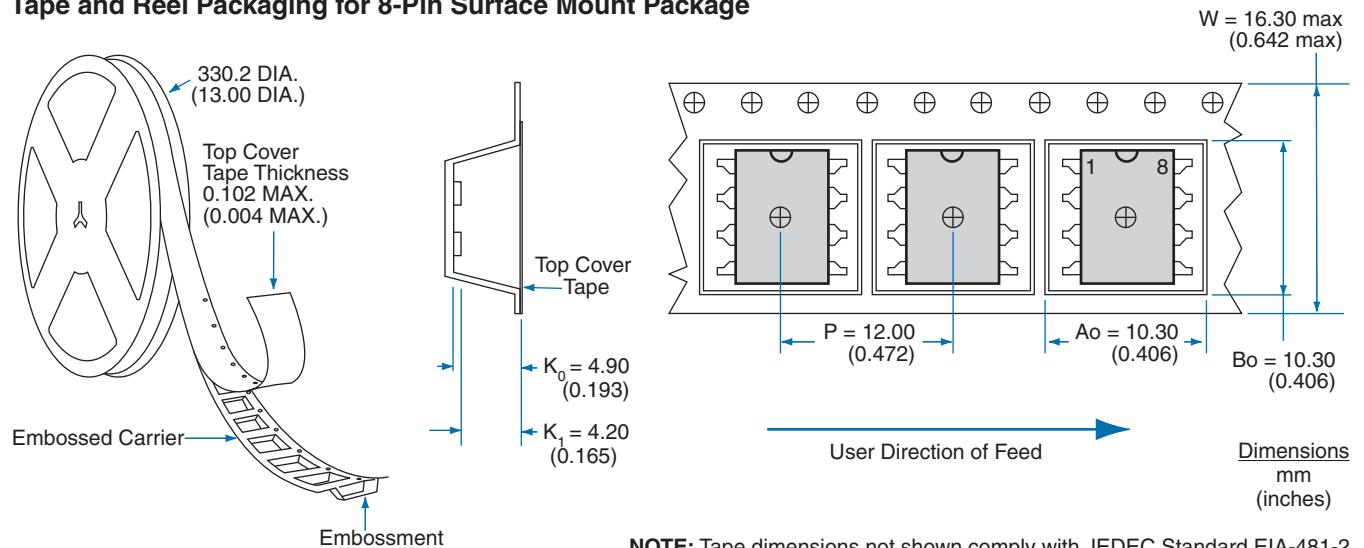

NOTE: Tape dimensions not shown comply with JEDEC Standard EIA-481-2

For additional information please visit our website at: www.clare.com

Clare, Inc. makes no representations or warranties with respect to the accuracy or completeness of the contents of this publication and reserves the right to make changes to specifications and product descriptions at any time without notice. Neither circuit patent licenses nor indemnity are expressed or implied. Except as set forth in Clare's Standard Terms and Conditions of Sale, Clare, Inc. assumes no liability whatsoever, and disclaims any express or implied warranty, relating to its products including, but not limited to, the implied warranty of merchantability, fitness for a particular purpose, or infringement of any intellectual property right.

The products described in this document are not designed, intended, authorized or warranted for use as components in systems intended for surgical implant into the body, or in other applications intended to support or sustain life, or where malfunction of Clare's product may result in direct physical harm, injury, or death to a person or severe property or environmental damage. Clare, Inc. reserves the right to discontinue or make changes to its products at any time without notice.

Specification: DS-PAA132-R02
©Copyright 2007, Clare, Inc.
OptoMOS® is a registered trademark of Clare, Inc.
All rights reserved. Printed in USA.
11/9/07